

**Important Preinstallation Note:** 4" square junction box supplied by others. Canopies and suspensions are supplied, two per individual fixture. **Junction box should be installed regressed 3/16" into ceiling. Do not handle fixtures without gloves. READ ALL INSTRUCTIONS THOROUGHLY BEFORE ATTEMPTING INSTALLATION.**

## LINCOR Cable-Mounted Continuous Fixtures

DANGER

**RISK OF FIRE AND ELECTRICAL SHOCK**

Contact, improper installation, or improper servicing MAY RESULT IN DEATH OR SERIOUS INJURY!

Fixture must be installed by a qualified electrician only. Fixture is intended for installation in accordance with the National Electrical Code, local and federal code specifications. Disconnect power at electrical panel before servicing. Retain these instructions for maintenance reference.

- 1 Unpack fixture.** Fixtures are shipped pre-assembled:
- Starters come with Power Cord along with pre-installed joiner
  - Mids come with pre-installed joiner

## 2 Determine spacing for mounting points.

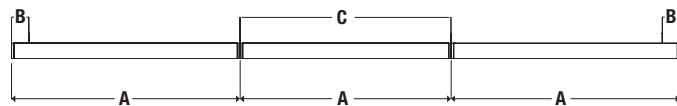

### A - Fixture Length

4ft Starter / End	47-1/2"
4ft Mid	47-3/8"
8ft Starter / End	94-5/8"
8ft Mid	94-1/2"

### B - Recommended minimum distance from endcap to suspension

1" min

### C - Distance between suspensions

4ft Mid	47-3/8"
8ft Mid	94-1/2"

**Fixture weights:**  
**4 ft. 7-1/2 lbs**  
**8 ft. 13-1/2 lbs**

## 3 Prepare ceiling/wall for junction box and suspension installation using method(s) below that apply to your installation.

All mounting points must be in a straight line. J-boxes must be mounted perpendicular to fixture center line as shown.

**a. Cable, Surface and Wall Mount – Install junction box (feed or non-feed) 3/16" above the finished ceiling surface.**

**b. Cable Mount – Hang cable-mounted suspension.** Screw cross bar bracket to junction box. Insert cable into keyhole in cross bar bracket.

**c. Cable Mount – 1/4-20 mounting:** Make sure that the stud is at least 1/2" below the ceiling tile.

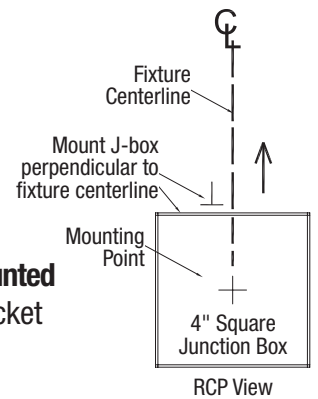
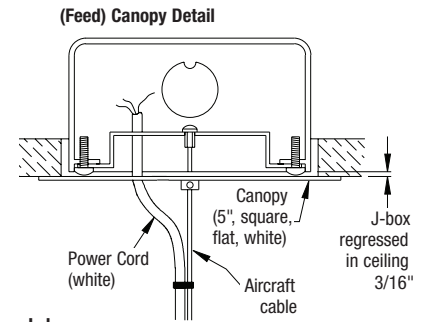

### J-box Mounted with Power Feed

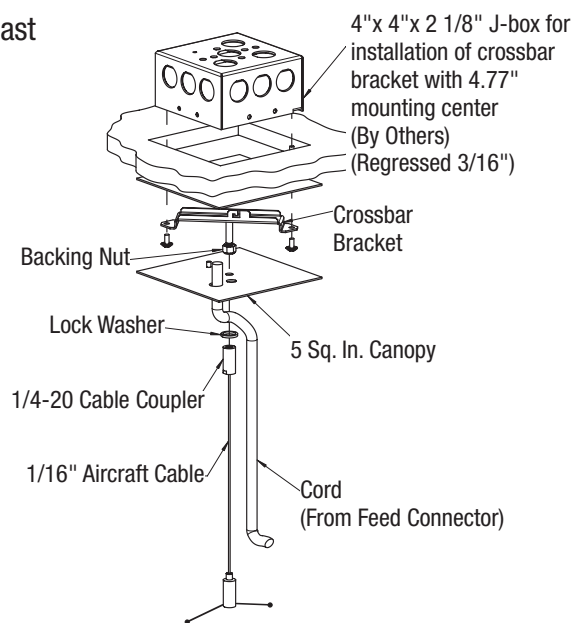

**Note: For feed locations, use canopy provided with power cord.**

**Questions? Problems? Call (800) 448-4131 and we will be happy to assist you. For technical specification sheets or other information about our products, please go to [www.zumtobel.us](http://www.zumtobel.us)**

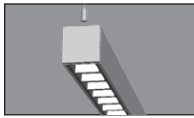

**Important Preinstallation Note:** 4" square junction box supplied by others. Canopies and suspensions are supplied, two per individual fixture. **Junction box should be installed regressed 3/16" into ceiling. Do not handle fixtures without gloves. READ ALL INSTRUCTIONS THOROUGHLY BEFORE ATTEMPTING INSTALLATION.**

**LINCOR**  
Cable-Mounted  
Continuous Fixtures

## DANGER

### RISK OF FIRE AND ELECTRICAL SHOCK



Contact, improper installation, or improper servicing MAY RESULT IN DEATH OR SERIOUS INJURY!

Fixture must be installed by a qualified electrician only. Fixture is intended for installation in accordance with the National Electrical Code, local and federal code specifications. Disconnect power at electrical panel before servicing. Retain these instructions for maintenance reference.

## 3 Continued.

**d. For T-bar mounting:** Attach T-bar support clip to T-bar ceiling. Make sure that T-bar support clip is attached close to junction box for easy wiring.

### T-bar Mounted with Power Feed

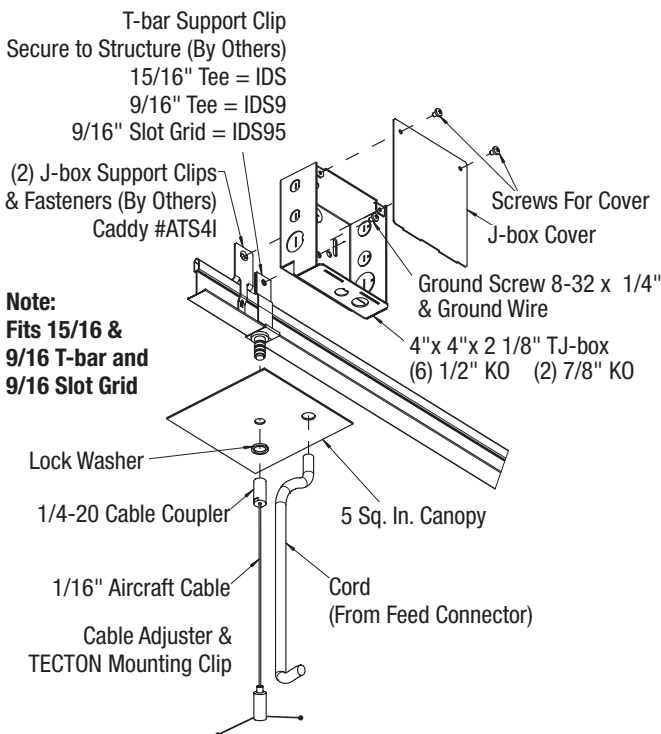

### 1/4-20 Fastener Non-Power Feed – 2" Canopy

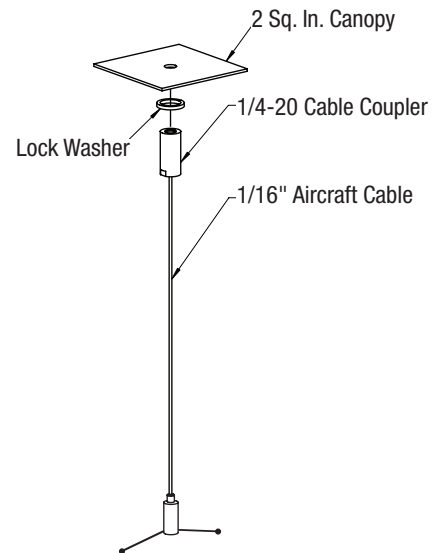

## 4 Starting with Starter fixture, insert the rounded end of the Double Suspension Cable Connector (DCBL) into the beginning of the Starter. Slide the DCBL to the end of the starter by the joiner. Insert rounded ends of Single Suspension Cable Connector (CBL) into the beginning of the Starter, and insert aircraft cable from ceiling into the cable connector.

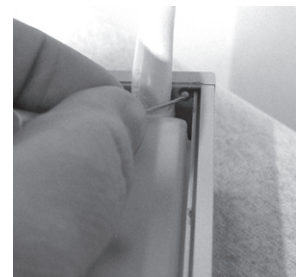

Press top of spring-loaded cable connector and release once the desired height is reached.

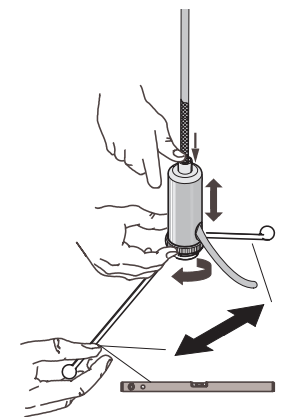

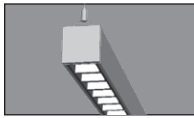

**Important Preinstallation Note:** 4" square junction box supplied by others. Canopies and suspensions are supplied, two per individual fixture. **Junction box should be installed regressed 3/16" into ceiling. Do not handle fixtures without gloves. READ ALL INSTRUCTIONS THOROUGHLY BEFORE ATTEMPTING INSTALLATION.**

**LINCOR**  
Cable-Mounted  
Continuous Fixtures

**⚠ DANGER**



**RISK OF FIRE AND ELECTRICAL SHOCK**

Contact, improper installation, or improper servicing MAY RESULT IN DEATH OR SERIOUS INJURY!

Fixture must be installed by a qualified electrician only. Fixture is intended for installation in accordance with the National Electrical Code, local and federal code specifications. Disconnect power at electrical panel before servicing. Retain these instructions for maintenance reference.

**5** Insert aircraft cable from next suspension point in the ceiling into the DCBL connector. This will support the Starter while you connect the next luminaire.

**6** Take the next fixture (whether it is a Mid or End) and remove the indirect lens, taking caution not to break the lens.

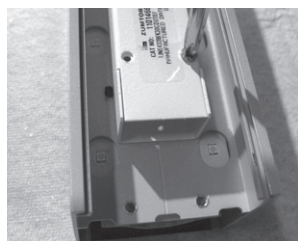
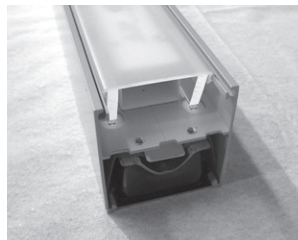
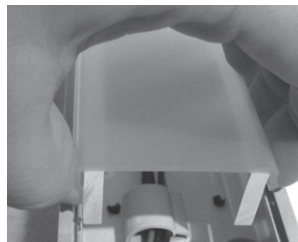

Then remove the wireway cover.

Keep the screws for Step 7.

**7** While someone supports the second fixture, make the connection from the connector in the Starter to the connector in the wireway of the second fixture.

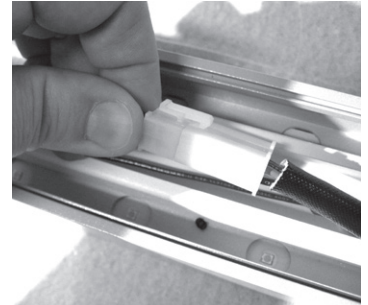

Reattach the wireway cover with the screws you removed in Step 6.



**8** While someone is still supporting the second fixture, insert the rounded ends of the DCBL connector into the channels of the second fixture.

Insert aircraft cable from ceiling into the cable connector. Press top of spring-loaded cable connector and release once the desired height is reached (see step 4).

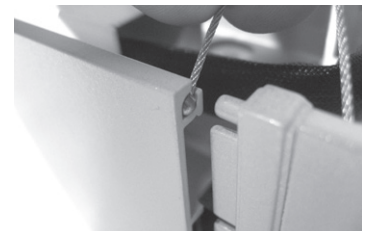

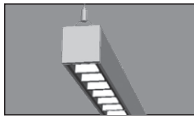

**Important Preinstallation Note:** 4" square junction box supplied by others. Canopies and suspensions are supplied, two per individual fixture. **Junction box should be installed regressed 3/16" into ceiling. Do not handle fixtures without gloves. READ ALL INSTRUCTIONS THOROUGHLY BEFORE ATTEMPTING INSTALLATION.**

**LINCOR**  
Cable-Mounted  
Continuous Fixtures

DANGER



**RISK OF FIRE AND ELECTRICAL SHOCK**

Contact, improper installation, or improper servicing MAY RESULT IN DEATH OR SERIOUS INJURY!

Fixture must be installed by a qualified electrician only. Fixture is intended for installation in accordance with the National Electrical Code, local and federal code specifications. Disconnect power at electrical panel before servicing. Retain these instructions for maintenance reference.

**9** Insert the pre-installed joiner from the Starter fixture into the second fixture, and insert (2) screws (provided), connecting the Starter and next fixture.

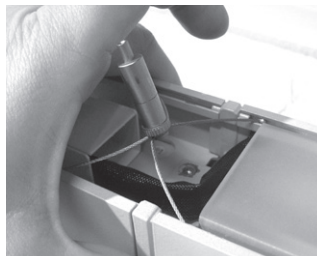

**10** Reinsert the lens into the second fixture by pressing starting at one end and working your way to the other end, being sure that all LEDs are covered.



**11** Continue with any additional fixtures, until you reach the last fixture in the row, repeating steps 5-10, being sure to insert the rounded ends of the DCBL connectors prior to attaching the 2 fixtures with the joiner and screws.

**12** When you reach the last fixture (End fixture), it will already have the endcap installed. Repeat steps 5-10, then remove the tape on the suspension cable connector, and insert aircraft cable from ceiling into the cable connector. Press top of spring-loaded cable connector and release once the desired height is reached (see Step 4).

**13** Level all fixtures in the row, then cut any additional aircraft cable coming from the connector to desired length.

**14** Make electrical connections in junction box using supplied power cord(s). Attach canopy ground wire to a suitable point in the junction box, per NEC and local codes.

**15** Place canopy onto stud to cover junction box. Repeat for all canopies.

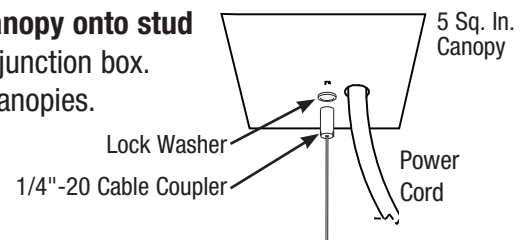

**16** Secure power cord to aircraft cable with wire ties provided. Wire ties provide strain relief.

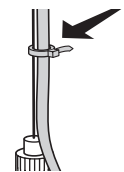

**17** Using gloves (provided), carefully remove the protective film from the minicell louvers and indirect lens. **DO NOT TOUCH THE MINICELL LOUVERS!**



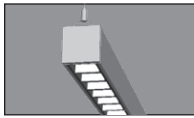

**Important Preinstallation Note:** 4" square junction box supplied by others. Canopies and suspensions are supplied, two per individual fixture. **Junction box should be installed regressed 3/16" into ceiling. Do not handle fixtures without gloves. READ ALL INSTRUCTIONS THOROUGHLY BEFORE ATTEMPTING INSTALLATION.**

## LINCOR Cable-Mounted Continuous Fixtures

**DANGER**

**RISK OF FIRE AND ELECTRICAL SHOCK**

Contact, improper installation, or improper servicing MAY RESULT IN DEATH OR SERIOUS INJURY!

Fixture must be installed by a qualified electrician only. Fixture is intended for installation in accordance with the National Electrical Code, local and federal code specifications. Disconnect power at electrical panel before servicing. Retain these instructions for maintenance reference.

### Installation of Remote EM driver in sheetrock ceiling

**1 Unpack fixture and Remote box.** Fixture is shipped pre-assembled with power cord attached and suspension cables in each end, which are taped to the fixture for shipping.

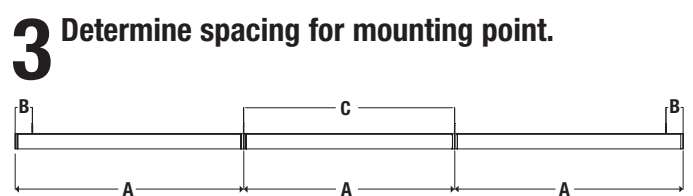
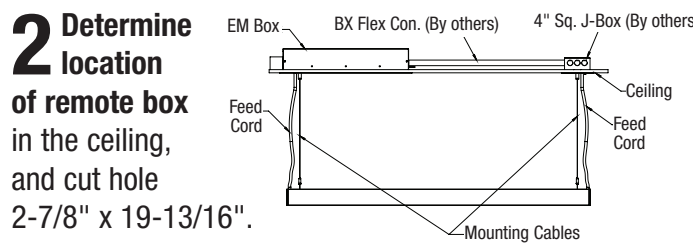

**A - Fixture Length**

4ft Starter / End	47-1/2"
4ft Mid	47-3/8"
8ft Starter / End	94-5/8"
8ft Mid	94-1/2"

**Fixture weights:**

<b>4 ft.</b>	<b>7-1/2 lbs</b>
<b>8 ft.</b>	<b>13-1/2 lbs</b>

**B - Recommended minimum distance from endcap to suspension**

1" min
--------

**C - Distance between suspensions**

4ft Mid	47-3/8"
8ft Mid	94-1/2"

**4 Prepare ceiling/wall for junction box and suspension installation using method(s) below that apply to your installation.**

All mounting points must be in a straight line. J-boxes must be mounted perpendicular to fixture center line as shown.

**a. Cable, Surface and Wall Mount –** Install junction box (feed or non-feed) 3/16" above the finished ceiling surface.

**b. Cable Mount – Hang cable-mounted suspension.** Screw cross bar bracket to junction box. Insert cable into keyhole in cross bar bracket.

**c. Cable Mount – 1/4-20 mounting:** Make sure that the stud is at least 1/2" below the ceiling tile.

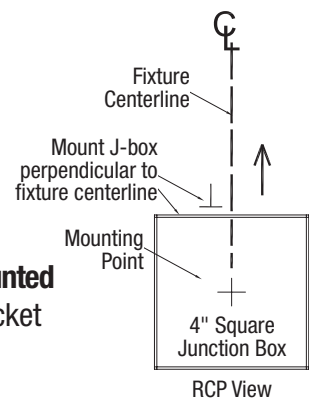
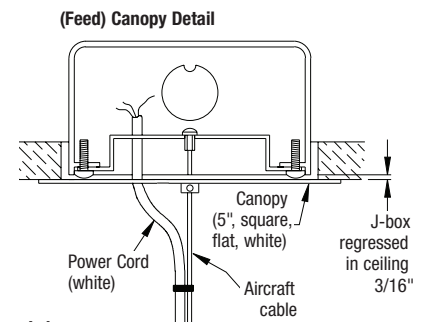

### J-box Mounted with Power Feed

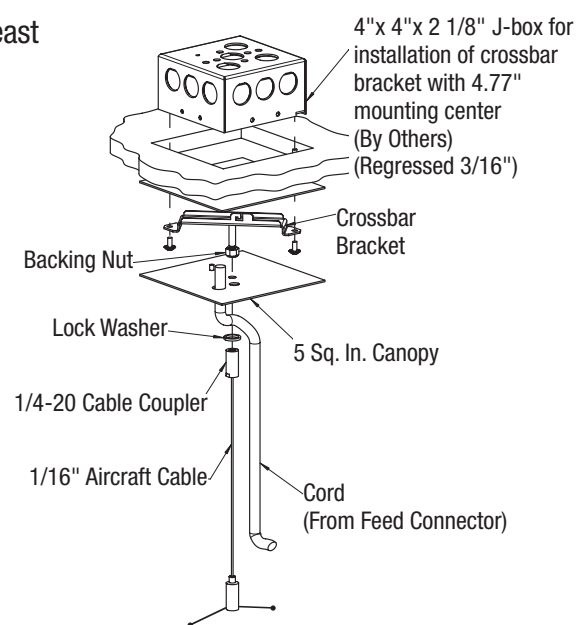

**Note:** For feed locations, use canopy provided with power cord.

**Questions? Problems? Call (800) 448-4131 and we will be happy to assist you. For technical specification sheets or other information about our products, please go to [www.zumtobel.us](http://www.zumtobel.us)**



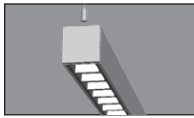

**Important Preinstallation Note:** 4" square junction box supplied by others. Canopies and suspensions are supplied, two per individual fixture. **Junction box should be installed regressed 3/16" into ceiling. Do not handle fixtures without gloves. READ ALL INSTRUCTIONS THOROUGHLY BEFORE ATTEMPTING INSTALLATION.**

**LINCOR**  
Cable-Mounted  
Continuous Fixtures

**DANGER**

**RISK OF FIRE AND ELECTRICAL SHOCK**

Contact, improper installation, or improper servicing MAY RESULT IN DEATH OR SERIOUS INJURY!

Fixture must be installed by a qualified electrician only. Fixture is intended for installation in accordance with the National Electrical Code, local and federal code specifications. Disconnect power at electrical panel before servicing. Retain these instructions for maintenance reference.

**4 Continued.**  
**d. For T-bar mounting:** Attach T-bar support clip to T-bar ceiling. Make sure that T-bar support clip is attached close to junction box for easy wiring.

### T-bar Mounted with Power Feed

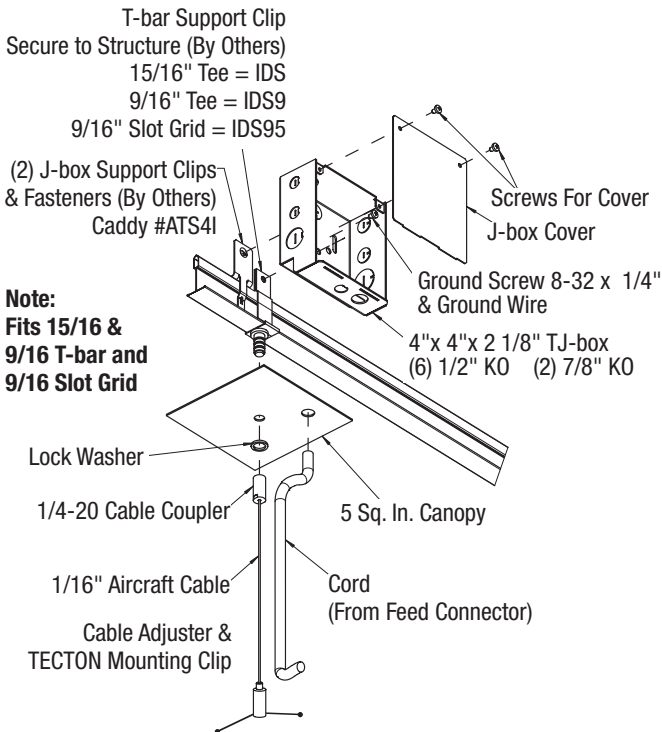

### 1/4-20 Fastener Non-Power Feed – 2" Canopy

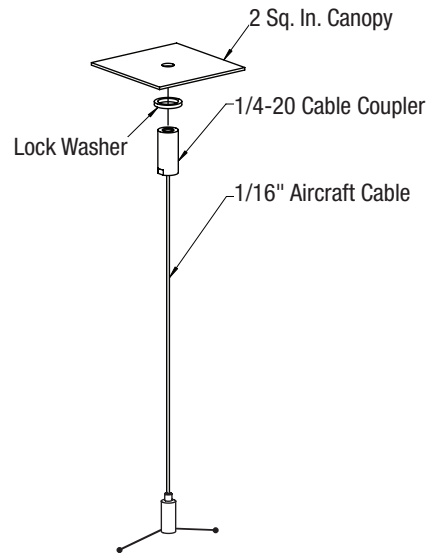

**5 Remove tape from suspension cable, and insert aircraft cable from ceiling into the cable connector.** Press top of spring-loaded cable connector and release once the desired height is reached.

Level fixture, then tighten the bottom of the cable connector.

Cut aircraft cable to desired length.

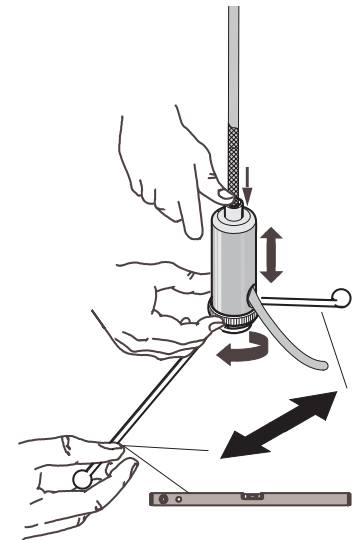
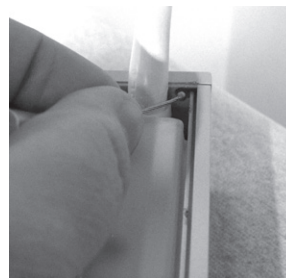

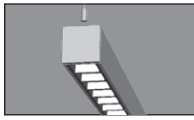

**Important Preinstallation Note:** 4" square junction box supplied by others. Canopies and suspensions are supplied, two per individual fixture. **Junction box should be installed regressed 3/16" into ceiling. Do not handle fixtures without gloves. READ ALL INSTRUCTIONS THOROUGHLY BEFORE ATTEMPTING INSTALLATION.**

**LINCOR**  
Cable-Mounted  
Continuous Fixtures

DANGER

**RISK OF FIRE AND ELECTRICAL SHOCK**

Contact, improper installation, or improper servicing MAY RESULT IN DEATH OR SERIOUS INJURY!

Fixture must be installed by a qualified electrician only. Fixture is intended for installation in accordance with the National Electrical Code, local and federal code specifications. Disconnect power at electrical panel before servicing. Retain these instructions for maintenance reference.

**6** Make electrical connections in junction box using supplied power cord. Attach canopy ground wire to a suitable point in the junction box, per NEC and local codes.

**7** Make connections in remote EM box per wiring diagram (see Page 8).

**8** Place canopy onto stud to cover junction box. Repeat for all canopies.

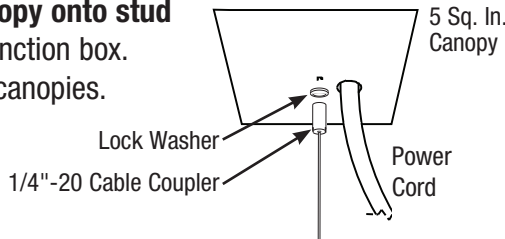

**9** Secure power cord to aircraft cable with wire ties provided. Wire ties provide strain relief.

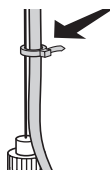

**10** Using gloves (provided), carefully remove the protective film from the minicell louvers and indirect lens. **DO NOT TOUCH THE MINICELL LOUVERS!**

## Standard Wire Color Legends

### 0-10V Dimming

STD DIMMING WIRE COLOR LEGENDS	
COLOR	CONNECTION
BLACK	HOT
WHITE	NEUTRAL
GREEN	GROUND
ORANGE	DIM +
BROWN	DIM-

### LUTRON Dimming

LUTRON WIRE COLOR LEGENDS	
COLOR	CONNECTION
BLACK	HOT
WHITE	NEUTRAL
GREEN	GROUND
ORANGE	E1
BROWN	E2

### DALI Dimming

DALI DIMMING WIRE COLOR LEGENDS	
COLOR	CONNECTION
BLACK	HOT
WHITE	NEUTRAL
GREEN	GROUND
ORANGE	D1
BROWN	D2

**Note:** Color code indicates standard color convention for drivers noted supplied with fixture unless otherwise indicated.

