

# Installation Instructions



**Important Preinstallation Note:** These instructions are for **accessible ceilings (lay-in or slot-grid)**. For other ceiling conditions, consult factory. Handle fixture by sheet metal sides only.

## LIGHT FIELDS™ LFULED/LFFLED Recessed LED Fixtures Accessible Ceilings (Lay-In and Slot-Grid)

**DO NOT REMOVE THE LED GEARTRAYS. THIS WILL VOID THE WARRANTY. Call Zumtobel at 1-800-448-4131 for questions.**

### **DANGER**

#### **RISK OF FIRE AND ELECTRICAL SHOCK**

Contact, improper installation, or improper servicing **MAY RESULT IN DEATH OR SERIOUS INJURY!**

Fixture must be installed by a qualified electrician only. Fixture is intended for installation in accordance with the National Electrical Code, local and federal code specifications. Disconnect power at electrical panel before servicing. Retain these instructions for maintenance reference.



**For 1x1 and 1x4 LFULED fixtures, the frame grid will need to be built out to size at the site with t-bar material.**

**1** **Unpack fixture(s).** Fixtures are shipped fully assembled.

**2** **Remove door frame** containing lens by pulling up at sides until it loosens, and then press spring ears together until frame detaches from housing. Keep door frame aside in safe location.



**3** **Remove access plate** from top of housing.

**4** **Attach access plate** to power supply. Knockout in access plate 1/2" conduit (7/8" dia.).

Flexible conduit or cable accessories by others

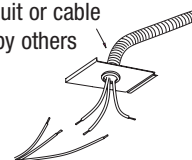

**5** **Lift the fixture into the ceiling system** and install, ensuring that the frame sits in the tees. Secure to ceiling structure per local codes. Handle fixture by sheet metal sides only.

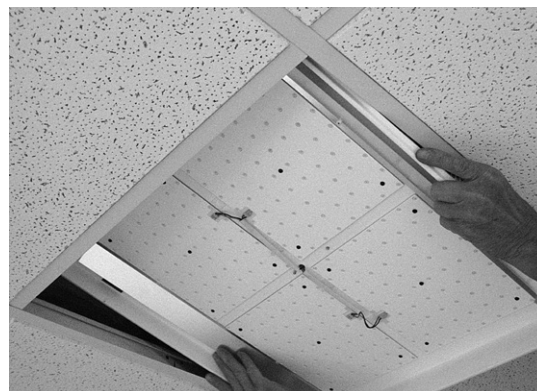

**NOTE:** National or municipal codes must be followed regarding fixture installation and set back of thermal insulating material from luminaire. As a guideline, any insulation material must be held away from the luminaire by a minimum of 3". Fixtures are not designed for direct contact with thermal insulation.

# Installation Instructions



**Important Preinstallation Note:** These instructions are for **accessible ceilings (lay-in or slot-grid)**. For other ceiling conditions, consult factory. Handle fixture by sheet metal sides only.

**LIGHT FIELDS™ LFULED/LFFLED  
Recessed LED Fixtures  
Accessible Ceilings (Lay-In and Slot-Grid)**

**DO NOT REMOVE THE LED GEARTRAYS. THIS WILL VOID THE WARRANTY. Call Zumtobel at 1-800-448-4131 for questions.**

## **DANGER**

### **RISK OF FIRE AND ELECTRICAL SHOCK**



Contact, improper installation, or improper servicing **MAY RESULT IN DEATH OR SERIOUS INJURY!**

Fixture must be installed by a qualified electrician only. Fixture is intended for installation in accordance with the National Electrical Code, local and federal code specifications. Disconnect power at electrical panel before servicing. Retain these instructions for maintenance reference.

**6 Make electrical connections** through access plate. Reinstall access plate in housing. Make sure wires do not get caught between plate and housing.

**7 Reattach door frame.** Reinstall springs by pressing ears together and inserting into slot or retaining bracket. Press up on door frame until it securely fits into fixture on all sides.



### **Maintenance - Turn off power first!**

- 1 Cleaning.** Wipe with a soft, lint-free cloth to avoid scratching the acrylic protective layer. Do not use glass cleaner or other solvents.
- 2 Access to driver.** Remove adjacent ceiling tile to access driver.
- 3 Replacement of LED boards.** Contact Zumtobel at 1 (800) 448-4131.

**WHEN REPLACING PCB ASSEMBLIES, PLEASE WEAR AN ESD WRIST STRAP AND CONNECT IT TO THE METAL ENCLOSURE.**

*Questions? Problems? Call (800) 448-4131 and we will be happy to assist you. For technical specification sheets or other information about our products, please go to [www.zumtobel.us](http://www.zumtobel.us)*



# Installation Instructions



**Important Preinstallation Note:** These instructions are for recessed LIGHT FIELDS™ to be mounted flangeless in inaccessible (gypsum board or selected concealed) ceilings. Plaster frame provided for gypsum board installations. For other ceiling conditions, consult factory.

## LIGHT FIELDS™ LED LFTLED 1x1 Recessed LED Fixtures Accessible Ceilings (Lay-In and Slot-Grid)

**DO NOT REMOVE THE LED GEARTRAYS. THIS WILL VOID THE WARRANTY. Call Zumtobel at 1-800-448-4131 for questions.**

DANGER



**RISK OF FIRE AND ELECTRICAL SHOCK**

Contact, improper installation, or improper servicing MAY RESULT IN DEATH OR SERIOUS INJURY!

Fixture must be installed by a qualified electrician only. Fixture is intended for installation in accordance with the National Electrical Code, local and federal code specifications. Disconnect power at electrical panel before servicing. Retain these instructions for maintenance reference.

- 1** **Unpack fixture(s).**  
Fixtures are shipped fully assembled.

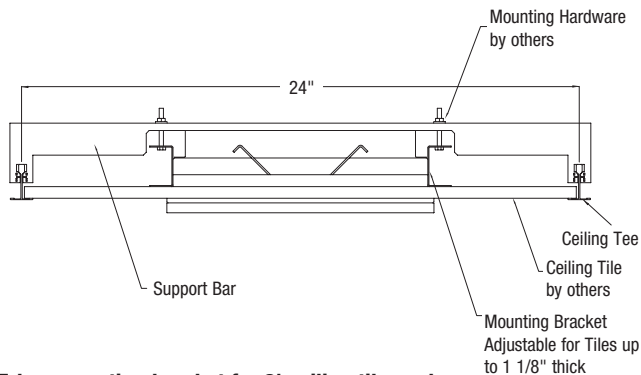
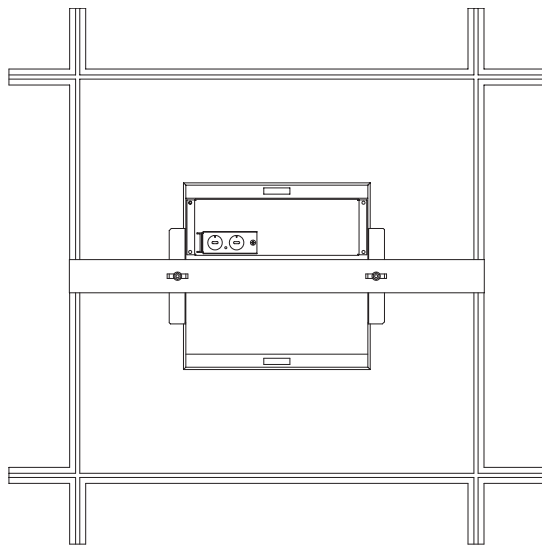

**T-bar mounting bracket for 2' ceiling tiles only.**

- 2** Use **template** (provided) to cut hole in center of ceiling grid. Hole should be 11 1/8" square.

- 3** Remove access plate from top of housing.

- 4** Insert fixture into tile from the bottom side.



- 5** Attach adjustable mounting bracket by installing screws into fixture housing. Adjust the height to secure the fixture to the grid and tighten screws.



- 6** Insert tile and fixture into ceiling grid.

# Installation Instructions



**Important Preinstallation Note:** These instructions are for recessed LIGHT FIELDS™ to be mounted flangeless in inaccessible (gypsum board or selected concealed) ceilings. Plaster frame provided for gypsum board installations. For other ceiling conditions, consult factory.

## LIGHT FIELDS™ LED LFTLED 1x1 Recessed LED Fixtures Accessible Ceilings (Lay-In and Slot-Grid)

**DO NOT REMOVE THE LED GEARTRAYS. THIS WILL VOID THE WARRANTY. Call Zumtobel at 1-800-448-4131 for questions.**

### **DANGER**

#### RISK OF FIRE AND ELECTRICAL SHOCK



Contact, improper installation, or improper servicing MAY RESULT IN DEATH OR SERIOUS INJURY!

Fixture must be installed by a qualified electrician only. Fixture is intended for installation in accordance with the National Electrical Code, local and federal code specifications. Disconnect power at electrical panel before servicing. Retain these instructions for maintenance reference.

*NOTE: National or municipal codes must be followed regarding fixture installation and set back of thermal insulating material from luminaire. As a guideline, any insulation material must be held away from the luminaire by a minimum of 3". Fixtures are not designed for direct contact with thermal insulation.*

**10** Make electrical connections through access plate. Reinstall access plate in housing. Make sure wires do not get caught between plate and housing.

#### For EM fixtures:

Install fixture following instructions above. To mount the remote EM pack, use the mounting brackets (provided) onto the adjacent grid.

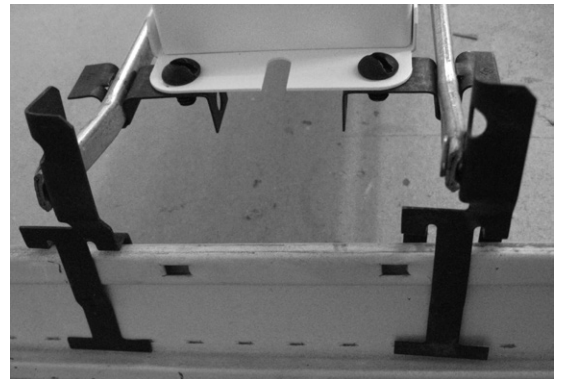

**7** Install 1/4-20 bolt (by others) into the mounting bracket.



**8** Bend tabs on support bar to accommodate grid.



**9** Attach support bar to grid, being sure to line up the bolt in the mounting bracket with the hole in the support bar. Bend out tabs on support bar to tighten to the grid. Tighten bolts in mounting bracket using washer and nut (by others).

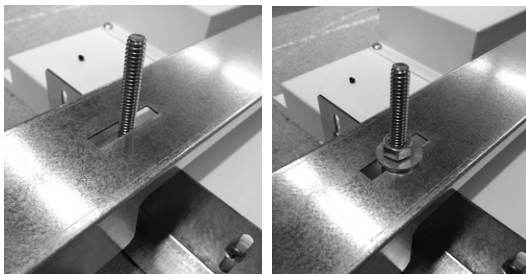

#### Maintenance - Turn off power first!

**1** **Cleaning.** Wipe with a soft, lint-free cloth to avoid scratching the acrylic protective layer. Do not use glass cleaner or other solvents.

**2** **Access to driver.** Remove door frame as in step 2. Remove fixture from plaster frame, and access ballast on back of fixture.

**3** **Replacement of LED boards.** Contact Zumtobel at 1 (800) 448-4131.

**WHEN REPLACING PCB ASSEMBLIES, PLEASE WEAR AN ESD WRIST STRAP AND CONNECT IT TO THE METAL ENCLOSURE.**

# Installation Instructions



**Important Preinstallation Note:** These instructions are for recessed LIGHT FIELDS™ to be mounted flangeless in inaccessible (gypsum board or selected concealed) ceilings. Plaster frame provided for gypsum board installations. For other ceiling conditions, consult factory.

**LIGHT FIELDS™ LFULED 2'x2' Cluster Recessed LED Fixtures Inaccessible Ceilings, Plaster Frame, Flangeless**

**DO NOT REMOVE THE LED GEARTRAYS. THIS WILL VOID THE WARRANTY. Call Zumtobel at 1-800-448-4131 for questions.**



**DANGER**



**RISK OF FIRE AND ELECTRICAL SHOCK**

Contact, improper installation, or improper servicing MAY RESULT IN DEATH OR SERIOUS INJURY!

Fixture must be installed by a qualified electrician only. Fixture is intended for installation in accordance with the National Electrical Code, local and federal code specifications. Disconnect power at electrical panel before servicing. Retain these instructions for maintenance reference.

**1 Unpack fixture(s) and prepare ceiling.** Fixtures are shipped fully assembled. Make ceiling cutout (depending on the quantity and configuration of Cluster fixtures).

- Ceiling cutout =**
- 1 □ 24 13/16" SQ
  - 2 ▢ 24 13/16" X 48 13/16"
  - 3 ▣ 24 13/16" X 72 13/16"
  - 4 ▤ 48 13/16" SQ
  - 6 ▥ 48 13/16" X 72 13/16"
  - 9 ▧ 72 13/16" SQ

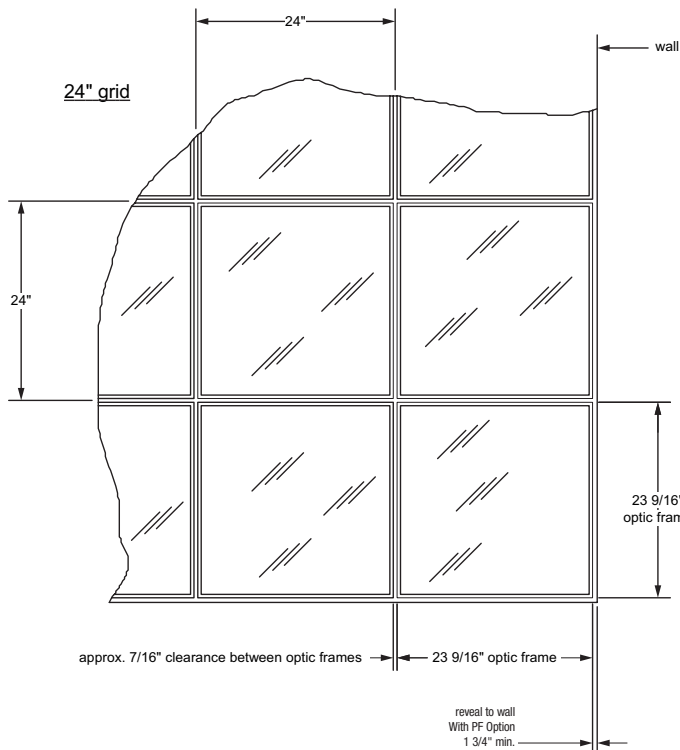

**2 Install supplied Plaster Frame** into ceiling cutout and firmly secure all four sides to building structure using screws (by others).

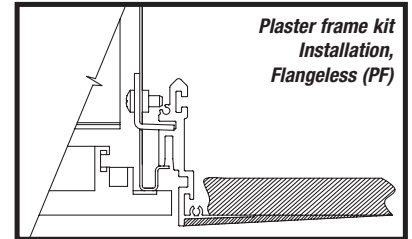

*Concealed Ceiling Plaster Frame Kit, Flangeless Appearance (PF option)*

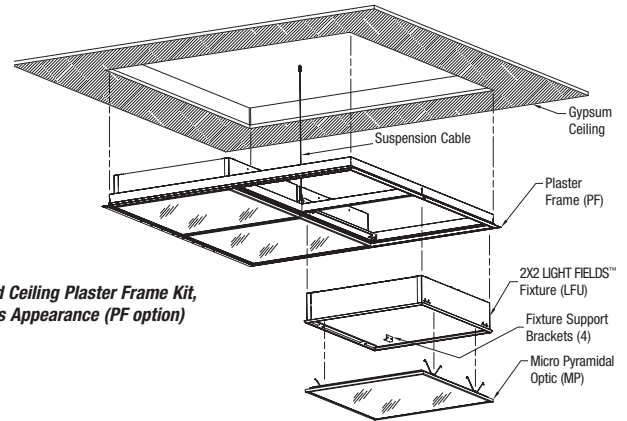

**3 Provide 1/4-20" cable support** from ceiling structure to center of frame. Tighten, making sure all sides are level. Cut excess cable.

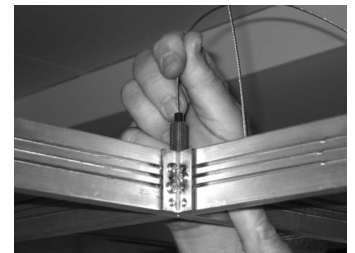

*Questions? Problems? Call (800) 448-4131 and we will be happy to assist you. For technical specification sheets or other information about our products, please go to [www.zumtobel.us](http://www.zumtobel.us)*



# Installation Instructions



**Important Preinstallation Note:** These instructions are for **recessed LIGHT FIELDS™** to be mounted flangeless in **inaccessible** (gypsum board or selected concealed) ceilings. Plaster frame provided for gypsum board installations. For other ceiling conditions, consult factory.

## LIGHT FIELDS™ LFULED 2'x2' Cluster Recessed Fluorescent Fixtures Inaccessible Ceilings, Plaster Frame, Flangeless

**DO NOT REMOVE THE LED GEARTRAYS. THIS WILL VOID THE WARRANTY. Call Zumtobel at 1-800-448-4131 for questions.**

DANGER

RISK OF FIRE AND ELECTRICAL SHOCK

Contact, improper installation, or improper servicing MAY RESULT IN DEATH OR SERIOUS INJURY!

Fixture must be installed by a qualified electrician only. Fixture is intended for installation in accordance with the National Electrical Code, local and federal code specifications. Disconnect power at electrical panel before servicing. Retain these instructions for maintenance reference.

**4 Remove door frame** containing prismatic diffuser by pulling up at sides until it loosens, and then press spring ears together until frame detaches from housing. Keep door frame aside in safe location.

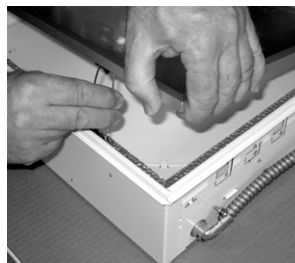

**5 Remove access plate** from top of housing.

**6 Attach access plate** to power supply. Knockout in access plate 1/2" conduit (7/8" dia.).

Flexible conduit or cable accessories by others

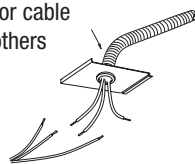

**7 Make electrical connections** through access plate. Reinstall access plate in housing. Make sure wires do not get caught between plate and housing.

**8 Lift the fixture** into the installed Plaster frame and engage mounting bracket into frame. Tighten screws. Secure to ceiling structure per local codes. Handle fixture by sheet metal sides only. Install multiple Cluster fixtures in the same manner.

*NOTE: National or municipal codes must be followed regarding fixture installation and set back of thermal insulating material from luminaire. As a guideline, any insulation material must be held away from the luminaire by a minimum of 2". Fixtures are not designed for direct contact with thermal insulation.*

**9 Install multiple Cluster fixtures** in the same manner.

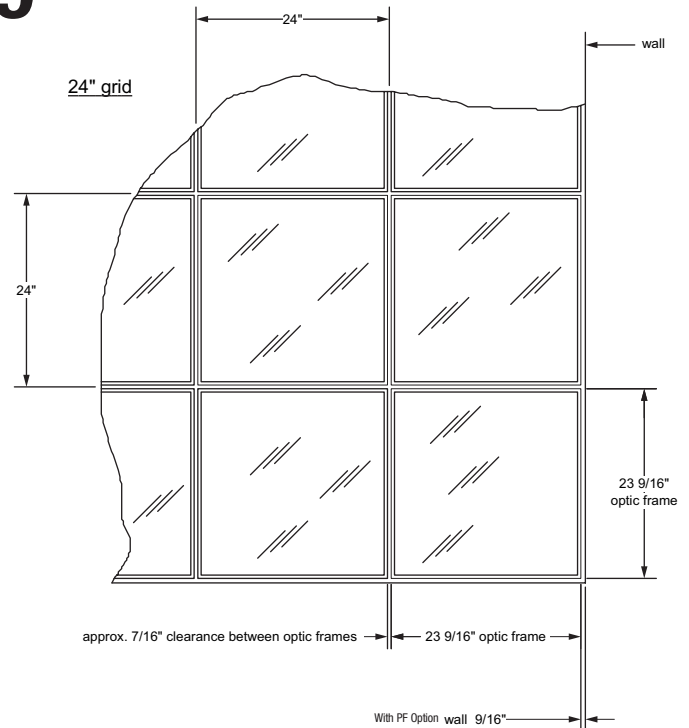

**10 Reattach door frame.** Reinstall springs by pressing ears together and inserting into slot or retaining bracket. Press up on door frame until it securely clicks into fixture on all sides.

### Maintenance - Turn off power first!

- 1 Cleaning.** Wipe with a soft, lint-free cloth to avoid scratching the acrylic protective layer. Do not use glass cleaner or other solvents.
- 2 Access to driver.** Remove door frame as in step 2. Remove fixture from plaster frame, and access ballast on back of fixture.
- 3 Replacement of LED boards.** Contact Zumtobel at 1 (800) 448-4131.

**WHEN REPLACING PCB ASSEMBLIES, PLEASE WEAR AN ESD WRIST STRAP AND CONNECT IT TO THE METAL ENCLOSURE.**

*Questions? Problems? Call (800) 448-4131 and we will be happy to assist you. For technical specification sheets or other information about our products, please go to [www.zumtobel.us](http://www.zumtobel.us)*

